

## DATASHEET

# OCU-430 UC275

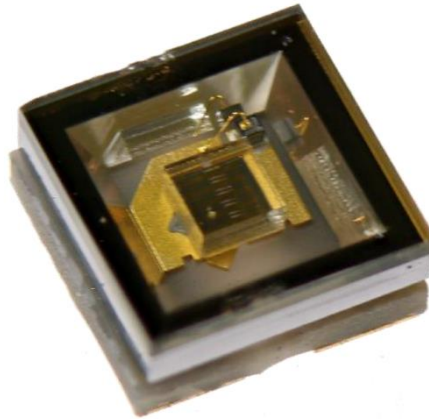

**Ceramic SMD Ultraviolet LED with Flat Top**

### Features:

- Footprint: 3535 (1414)
- Size: 3.5(L) x 3.5(W) x 1.4(H) mm
- Circuit substrate: AlN Ceramics
- ROHS and REACH compliant
- Lead-free solderable
- All devices sorted into intensity classes
- Taped in 12 mm blister tape
- Taping: face-up (T)

### Applications:

- Sensing
- Medical
- Disinfection

This 275 nm UV-A SMD LED is engineered for precision in advanced UV disinfection or sensing solutions. Flat design is well suited for compact applications.

## Typical Electro-Optical Characteristics

Measurement conditions

 $T_{\text{ambient}} = 23\text{ °C}$ ;  $t_{\text{test}} \leq 60\text{ ms}$ 

Parameter	Symbol	Condition	Min	Typ	Max	Unit
Emitting Color				Ultraviolet		
Forward Voltage	$V_f$	$I_f = 100\text{ mA}$		6		V
Peak Wavelength	$\lambda_p$	$I_f = 100\text{ mA}$		275		nm
FWHM	$\Delta\lambda$	$I_f = 100\text{ mA}$		12		nm
Radiant Intensity <sup>(1)</sup>	$I_e$	$I_f = 100\text{ mA}$	3.5	7.2		mW/sr
Radiant Power	$\Phi_e$	$I_f = 100\text{ mA}$		28		mW
View Angle	$\theta$	$I_f = 100\text{ mA}$		100		deg.
Reverse Current <sup>(2)</sup>	$I_R$	$V_R = 5\text{ V}$			-	$\mu\text{A}$

(1) Measured according to the CIE 127, Condition B

(2) LED should never be operated with reverse bias

## Maximum Ratings

Parameter	Symbol	Min	Max	Unit
Forward Current	$I_{f, \text{max}}$		150	mA
Forward Current, pulsed	$I_{f, \text{pulse}}$	$t_p \leq 100\mu\text{s}, \tau=1:10$	225	mA
Reverse Voltage	$V_R$		—	V
Thermal Resistance Junction – Solder point	$R_{\text{th,JS}}$	10	5	K/W
Operating Temperature	$T_{\text{op}}$	-40	+85	°C
Storage Temperature	$T_{\text{st}}$	-40	+85	°C

Electrostatic discharge classification (MIL-STD-883): Class 1



## Typical Performance

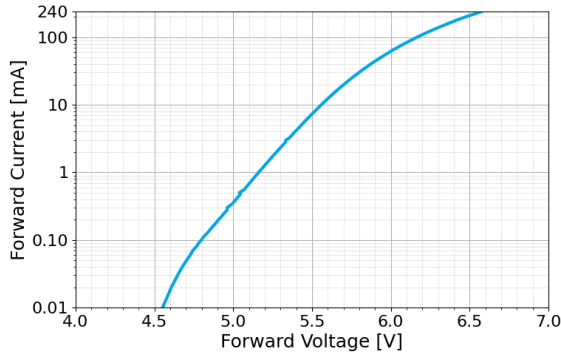

**Forward Current vs. Forward Voltage**

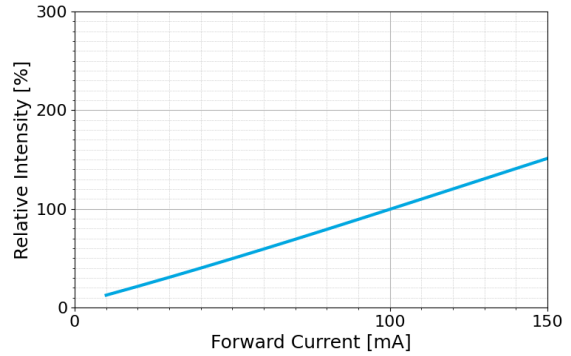

**Relative Intensity vs. Forward Current**

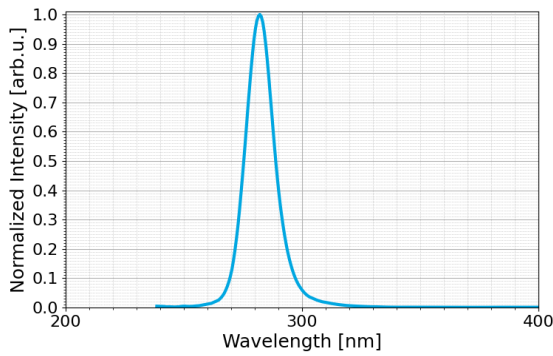

**Optical Spectrum**

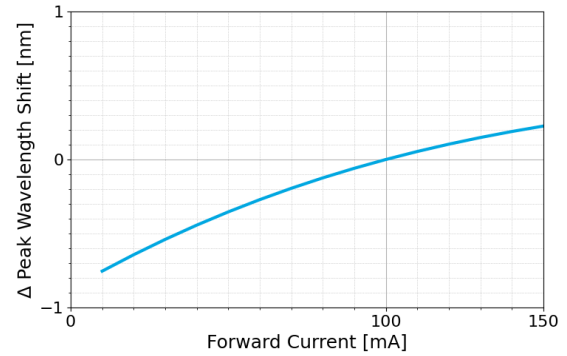

**Wavelength Shift vs. Forward Current**

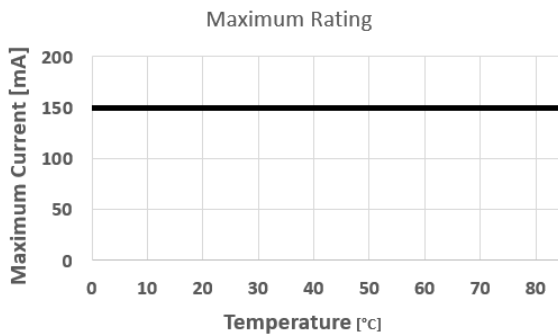

**Maximum Ratings <sup>(1)</sup>**

(1) Assuming connection to an infinite heatsink if not stated otherwise

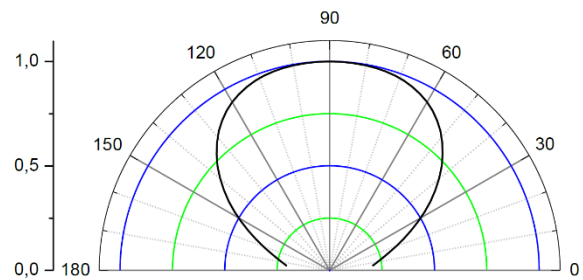

**Radiation Pattern**

## Outline Drawing

Unless otherwise specified, all drawing units are in mm  
Tolerances are: ISO 2768-m

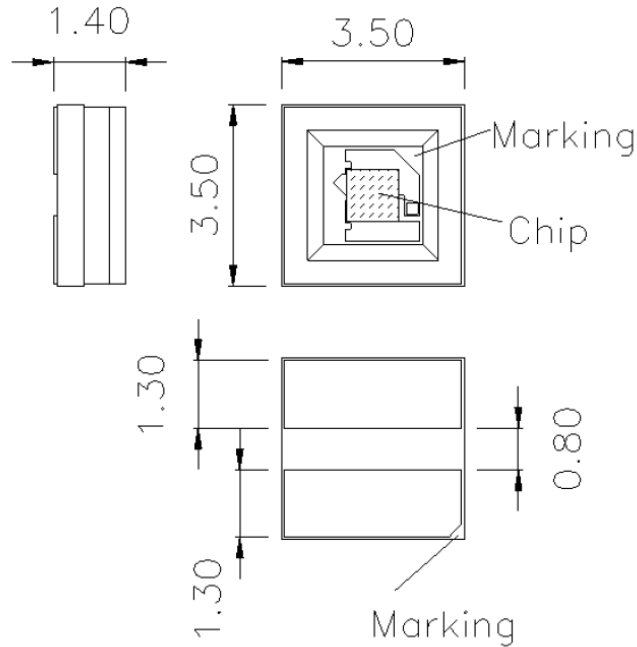

Marking at the Anode side.

## Recommended soldering pad

Unless otherwise specified, all drawing units are in mm

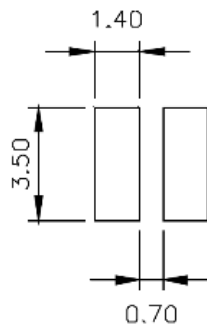

recommended max. thermal resistance  
device – ambient: 10 K/W

## Soldering Profile

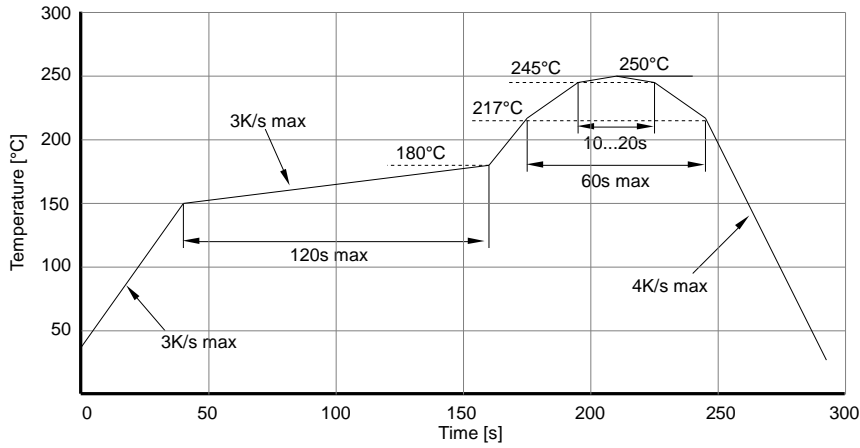

IR reflow  
soldering  
profile for lead  
free soldering

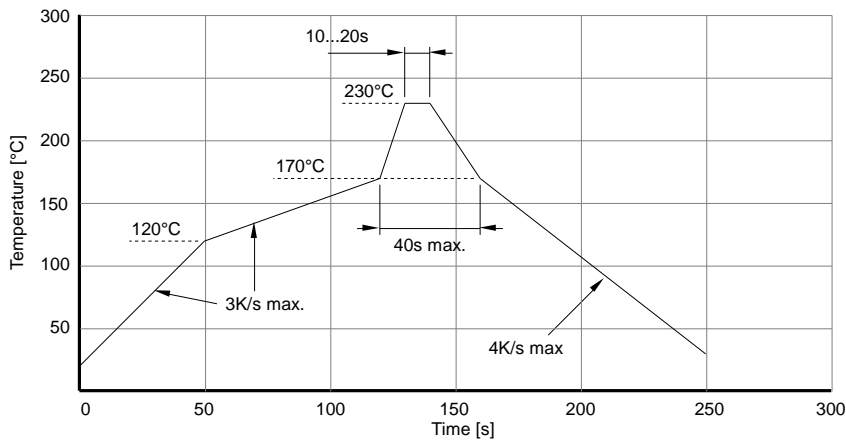

IR reflow  
soldering profile  
for solder  
containing lead

### Manual Soldering:

Maximum soldering iron power, temperature and time 25 W / 300 °C for 3 s.

## Tape And Reel Packaging

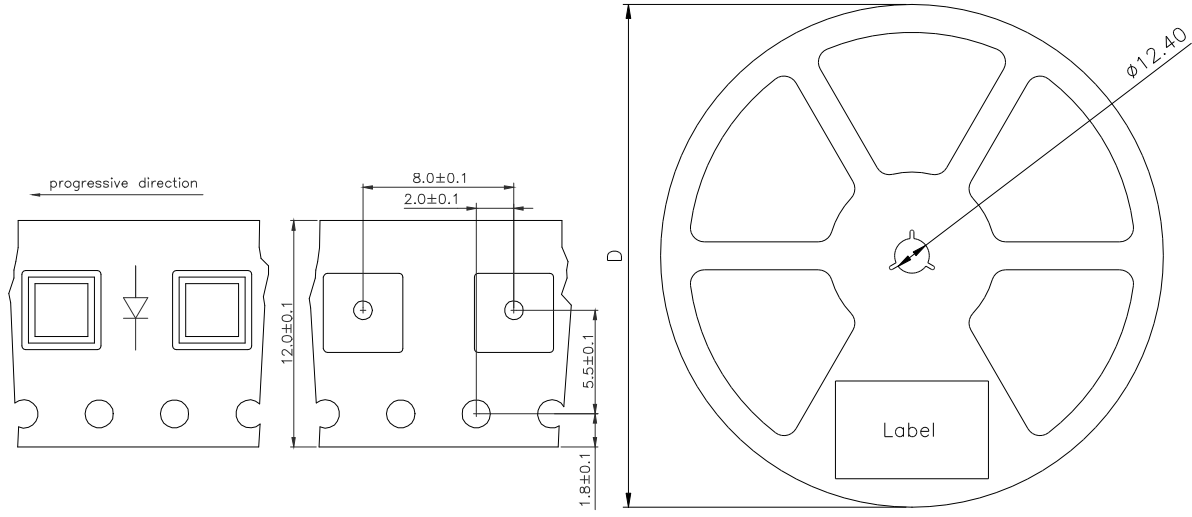

D	Parts/reel
7"	1000

### Packaging

The reel is sealed in a special plastic bag with integrated ESD protection including a silica dry-pack. Shelf life for sealed bag: 12 months on max. 30 °C and 60% Rh. Floor life: 12 months under max. 30 °C and 60% Rh in a dust free environment. Other bags (i.e. MBB, HIC, Vacuum pack, etc.) available on request.

**LED Intensity Groups [mW/sr]**

All SMD-LED devices are 100% measured and sorted into intensity groups with an accuracy of  $\pm 11\%$ . Intensity group is measured according to CIE 127.

*General information – not this specific device.*

C:	0.28	-	0.45
D:	0.45	-	0.71
E:	0.71	-	1.12
F:	1.12	-	1.80
G:	1.80	-	2.80
H:	2.80	-	4.50
J:	4.50	-	7.10
K:	7.10	-	11.20
L:	11.20	-	18.00
M:	18	-	28
N:	28	-	45
P:	45	-	71
Q:	71	-	112
R:	112	-	180
S:	180	-	280
T:	280	-	450
U:	450	-	710
V:	710	-	1120
AW:	1120	-	1800
BW:	1800	-	2800
CW:	2800	-	4500
DW:	4500	-	7100
EW:	7100	-	11 200
FW:	11 200	-	18 000
GW:	18 000	-	28 000
HW:	28 000	-	45 000
JW:	45 000	-	71 000
KW:	71 000	-	112 000
LW:	112 000	-	180 000
MW:	180 000	-	280 000

**Special service:** EPIGAP OSA offers Radiant intensity selection (binning) in sub selections.

Color selection in 3 sub-selections possible (each subgroup on a separate reel).

Information on available sub-groups can be accessed through this link:

[https://www.epigap-osa.com/datasheet/SMD\\_LED\\_Intensity\\_Groups\\_And\\_Subgroups\\_EPIGAP\\_OSA.pdf](https://www.epigap-osa.com/datasheet/SMD_LED_Intensity_Groups_And_Subgroups_EPIGAP_OSA.pdf)

## Warnings (UV light)

- **While in operation UV LEDs emit intense but mainly invisible ultraviolet radiation, which may be harmful to eyes, even for brief periods.**
- **Do not look directly into the UV LED during operation.**
- **Be sure that you and everyone in the vicinity wear safety goggles that provide suitable UV protection when operating a UV LED.**
- **Please follow all standard procedures for storing, handling, cleaning, mounting, soldering, disposing, or otherwise handling LED dies or packaged LEDs, including static electricity protection.**
- **The user has the responsibility to inform, train and instruct, customers and employees of the dangers to eye safety.**
- **UV LEDs are ESD sensitive (Class1). Handling and use of UV LEDs must be compatible with the ESD sensitivity rating.**

## Notice

The information describes the type of component and shall not consider as assured characteristics. Terms of delivery and rights to change reserved. The data sheet may change without prior notification; the only valid issue and current revision can be on our website. Due to technical requirements, components may contain dangerous substances.

It is the responsibility of the customer to evaluate and ensure that the use of the products in their specific applications complies with relevant safety standards and regulations. Customers must assess the exposure conditions within their systems and ensure that appropriate measures are taken to prevent exceeding the permissible exposure limits outlined in IEC 62471. EPIGAP OSA Photonics GmbH does not assume liability for any non-compliance arising from the integration or usage of LEDs in customer systems.

Parameters can vary in different applications. The customer must validate all operating parameters for each application. EPIGAP OSA Photonics GmbH does not have the responsibility for the reliability and the degradation behavior of products made with EPIGAP OSA Photonics GmbH diodes as they depend not only on the product itself but also on the operation, manufacturing or design of the final products. The customer is responsible for ensuring the long-term stability of the product according to their requirements. If components are used in toys or, life support systems, EPIGAP OSA Photonics GmbH must expressly authorize the use of the components prior to incorporating them into the customer's systems!  
Packaging: EPIGAP OSA Photonics GmbH uses recyclable packages.

## EPIGAP OSA Photonics GmbH

[www.epigap-osa.de](http://www.epigap-osa.de)

Köpenicker Str.325  
12555 Berlin Germany  
Tel. +49 (0)30 6576 3764  
[sales@epigap-osa.de](mailto:sales@epigap-osa.de)

