

DATASHEET

OCI-480 IT940

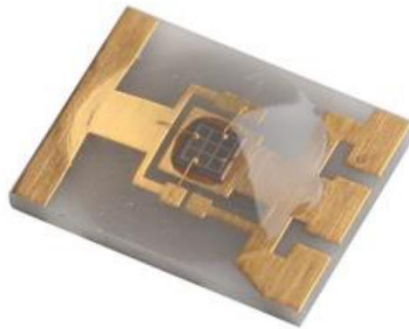

High Power Infrared LED with Glob Top

Features:

- Footprint: 6046 (2318)
- Size: 6.0(L) x 4.6(W) x 1.1(H) mm
- Circuit substrate: Ceramics
- ROHS and REACH compliant
- Lead-free solderable
- All devices sorted into intensity classes
- Taped in 16 mm blister tape
- Taping: face-up (T)

Applications:

- Sensing
- Life Science
- Safety
- Medical

This 940 nm high power infrared SMD LED is engineered for in body blood analysis. A glob top cover protects the device from environmental or mechanical stress.

Typical Electro-Optical Characteristics

Measurement conditions

 $T_{\text{ambient}} = 23\text{ °C}$; $t_{\text{test}} \leq 60\text{ ms}$

Parameter	Symbol	Condition	Min	Typ	Max	Unit
Emitting Color	Infrared					
Forward Voltage	V_f	$I_f = 350\text{ mA}$		1.4	1.8	V
		$I_f = 1000\text{ mA}$		1.6		
Peak Wavelength	λ_p	$I_f = 350\text{ mA}$	925	940	955	nm
		$I_f = 1000\text{ mA}$		940		
FWHM	$\Delta\lambda$	$I_f = 350\text{ mA}$		40		nm
		$I_f = 1000\text{ mA}$		50		
Radiant Intensity ⁽¹⁾	I_e	$I_f = 350\text{ mA}$	45	80		mW/sr
		$I_f = 1000\text{ mA}$		210		
Radiant Power	Φ_e	$I_f = 350\text{ mA}$		180		mW
		$I_f = 1000\text{ mA}$		500		
View Angle	θ	$I_f = 350\text{ mA}$		140		deg.
Reverse Current	I_R	$V_R = 5\text{ V}$			10	μA

(1) Measured according to the CIE 127, Condition B

Maximum Ratings

Parameter	Symbol	Min	Max	Unit
Forward Current	$I_{f, \text{max}}$		1000	mA
Forward Current, pulsed	$I_{f, \text{pulse}}$	$t_p \leq 100\mu\text{s}, \tau=1:10$	1200	mA
Reverse Voltage	V_R		5	V
Thermal Resistance Junction – Solder point	$R_{\text{th, JS}}$		5	K/W
Operating Temperature	T_{op}	-40	+85	°C
Storage Temperature	T_{st}	-40	+85	°C

Typical Performance

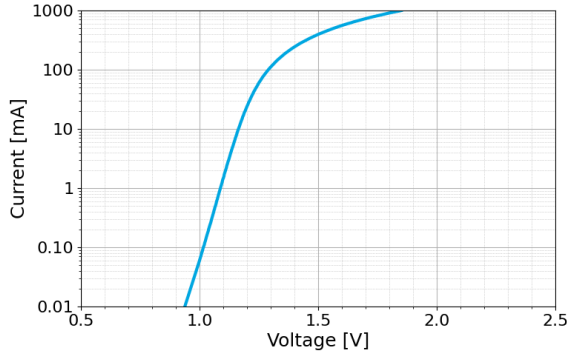

Forward Current vs. Forward Voltage

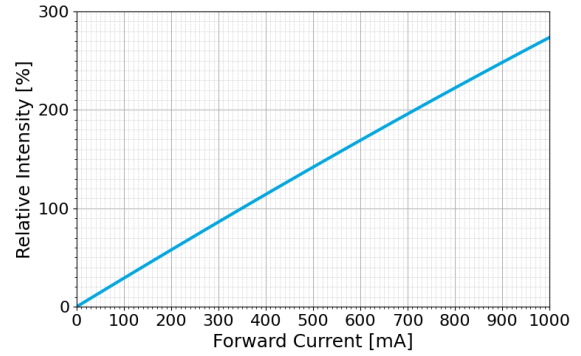

Relative Intensity vs. Forward Current

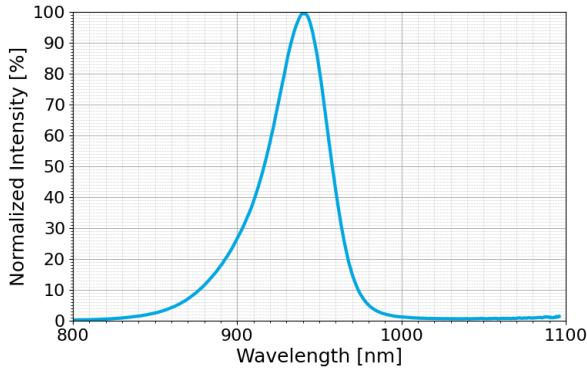

Optical Spectrum

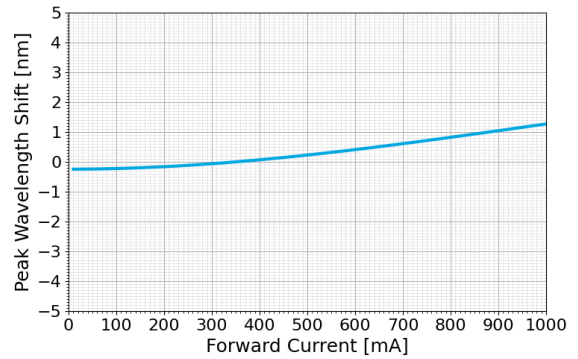

Wavelength Shift vs. Forward Current

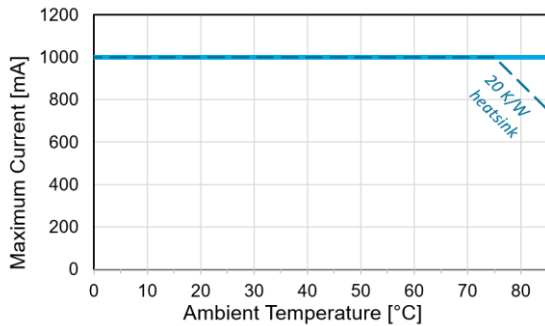

Maximum Ratings⁽¹⁾

(1) Assuming connection to an infinite heatsink if not stated otherwise

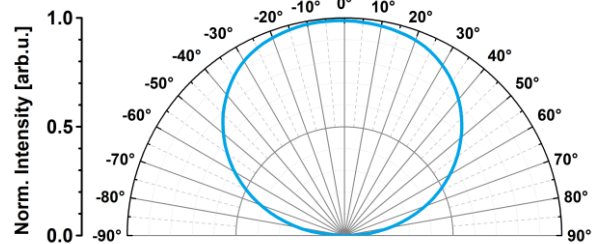

Radiation Pattern

Outline Drawing

Unless otherwise specified, all drawing units are in mm
Tolerances are: ISO 2768-m

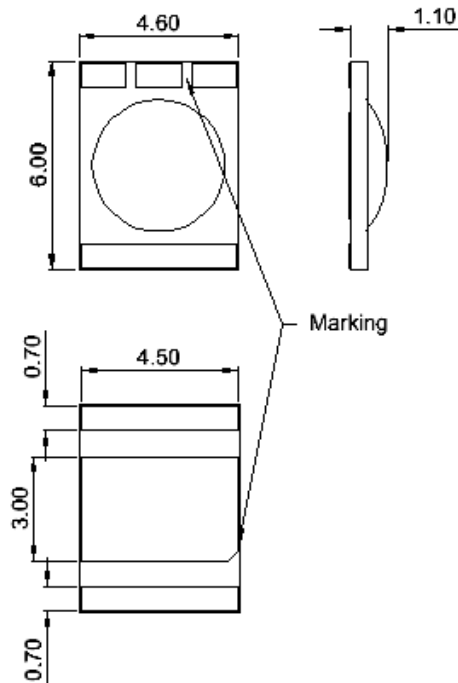

Marking at the Anode side.

Recommended soldering pad

Unless otherwise specified, all drawing units are in mm

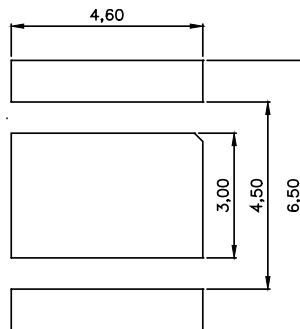

Soldering Profile

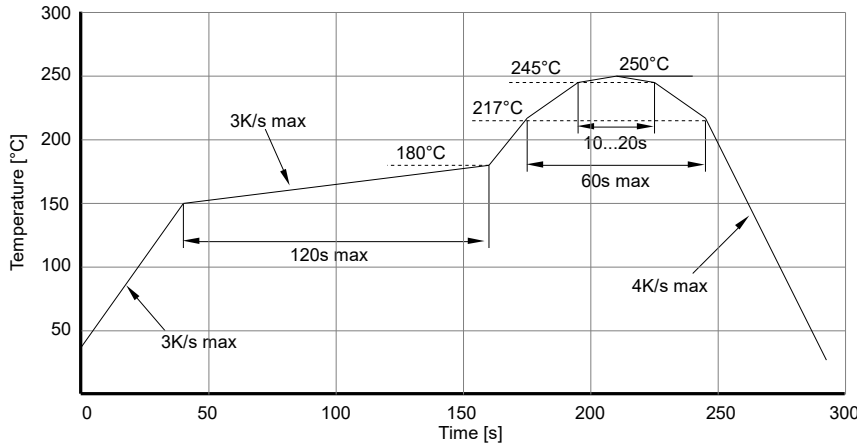

IR reflow soldering profile for lead free soldering

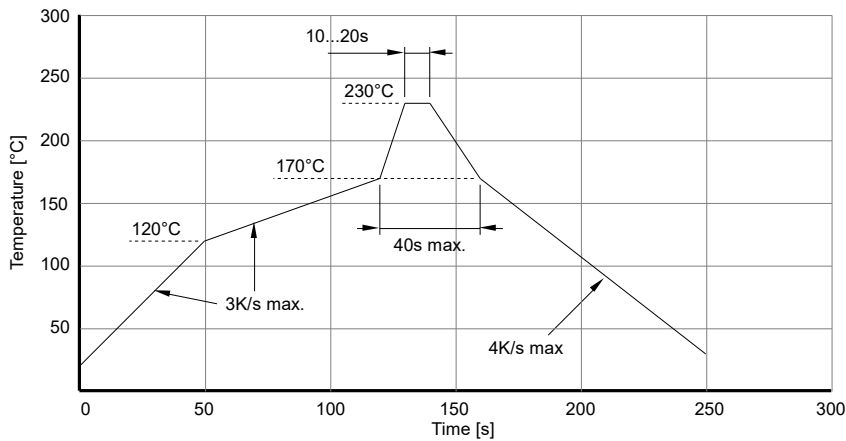

IR reflow soldering profile for solder containing lead

Manual Soldering: Not applicable for manual soldering.

Tape And Reel Packaging

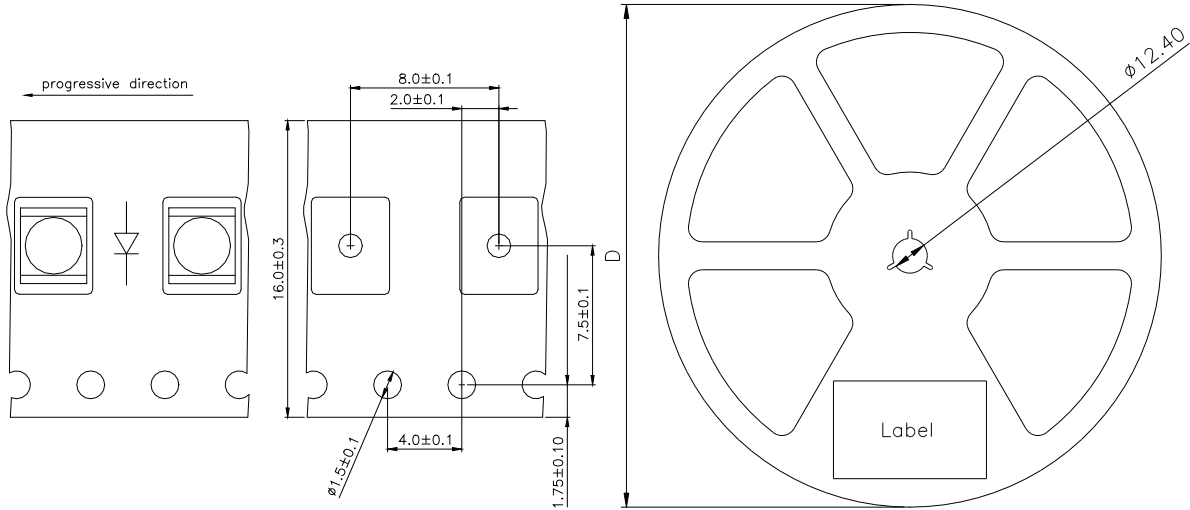

D	Parts/reel
7"	800

Packaging

The reel is sealed in a special plastic bag with integrated ESD protection including a silica dry-pack. Shelf life for sealed bag: 12 months on max. 30 °C and 60% Rh. Floor life: 12 months under max. 30 °C and 60% Rh in a dust free environment. Other bags (i.e. MBB, HIC, Vacuum pack, etc.) available on request.

LED Intensity Groups [mW/sr]

All SMD-LED devices are 100% measured and sorted into intensity groups with an accuracy of $\pm 11\%$. Intensity group is measured according to CIE 127.

General information – not this specific device.

C:	0.28	-	0.45
D:	0.45	-	0.71
E:	0.71	-	1.12
F:	1.12	-	1.80
G:	1.80	-	2.80
H:	2.80	-	4.50
J:	4.50	-	7.10
K:	7.10	-	11.20
L:	11.20	-	18.00
M:	18	-	28
N:	28	-	45
P:	45	-	71
Q:	71	-	112
R:	112	-	180
S:	180	-	280
T:	280	-	450
U:	450	-	710
V:	710	-	1120
AW:	1120	-	1800
BW:	1800	-	2800
CW:	2800	-	4500
DW:	4500	-	7100
EW:	7100	-	11 200
FW:	11 200	-	18 000
GW:	18 000	-	28 000
HW:	28 000	-	45 000
JW:	45 000	-	71 000
KW:	71 000	-	112 000
LW:	112 000	-	180 000
MW:	180 000	-	280 000

Special service: EPIGAP OSA offers Radiant intensity selection (binning) in sub selections.

Color selection in 3 sub-selections possible (each subgroup on a separate reel).

Information on available sub-groups can be accessed through this link:

https://www.epigap-osa.com/datasheet/SMD_LED_Intensity_Groups_And_Subgroups_EPIGAP_OSA.pdf

Warnings (UV light)

- **While in operation UV LEDs emit intense but mainly invisible ultraviolet radiation, which may be harmful to eyes, even for brief periods.**
- **Do not look directly into the UV LED during operation.**
- **Be sure that you and everyone in the vicinity wear safety goggles that provide suitable UV protection when operating a UV LED.**
- **Please follow all standard procedures for storing, handling, cleaning, mounting, soldering, disposing, or otherwise handling LED dies or packaged LEDs, including static electricity protection.**
- **The user has the responsibility to inform, train and instruct, customers and employees of the dangers to eye safety.**
- **UV LEDs are ESD sensitive (Class1). Handling and use of UV LEDs must be compatible with the ESD sensitivity rating.**

Notice

The information describes the type of component and shall not consider as assured characteristics. Terms of delivery and rights to change reserved. The data sheet may change without prior notification; the only valid issue and current revision can be on our website. Due to technical requirements, components may contain dangerous substances.

It is the responsibility of the customer to evaluate and ensure that the use of the products in their specific applications complies with relevant safety standards and regulations. Customers must assess the exposure conditions within their systems and ensure that appropriate measures are taken to prevent exceeding the permissible exposure limits outlined in IEC 62471. EPIGAP OSA Photonics GmbH does not assume liability for any non-compliance arising from the integration or usage of LEDs in customer systems.

Parameters can vary in different applications. The customer must validate all operating parameters for each application. EPIGAP OSA Photonics GmbH does not have the responsibility for the reliability and the degradation behavior of products made with EPIGAP OSA Photonics GmbH diodes as they depend not only on the product itself but also on the operation, manufacturing or design of the final products. The customer is responsible for ensuring the long-term stability of the product according to their requirements. If components are used in toys or, life support systems, EPIGAP OSA Photonics GmbH must expressly authorize the use of the components prior to incorporating them into the customer's systems!
Packaging: EPIGAP OSA Photonics GmbH uses recyclable packages.

EPIGAP OSA Photonics GmbH

www.epigap-osa.de

Köpenicker Str.325
12555 Berlin Germany
Tel. +49 (0)30 6576 3764
sales@epigap-osa.de