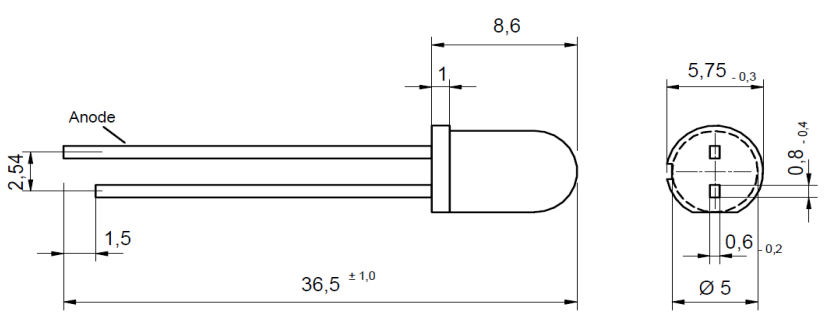

Data sheet

Infrared LED

EOLD-810-525

Radiation	Type	Case
Infrared	AlGaAs/AlGaAs, DDH	5 mm plastic lens

	<p>Description:</p> <p>High-power, high-speed infrared LED, with lens for narrow beam angle, and high reliability, housing without standoff leads</p>
	<p>Applications:</p> <p>Optical communications, safety equipment, automation, optical sensors</p>

All dimensions in mm

Maximum Ratings

T_{amb} = 25°C, unless otherwise specified

Parameter	Test Conditions	Symbol	Value	Unit
Forward current		I _F	100	mA
Peak forward current	t _p ≤ 50 μs, t _p /T = 1/2	I _{FM}	200	mA
Power dissipation		P _D	240	mW
Operating temperature range		T _{amb}	-20 to +80	°C
Storage temperature range		T _{stg}	-40 to +85	°C
Junction temperature		T _J	100	°C

Optical and Electrical Characteristics

T_{amb} = 25°C, unless otherwise specified

Parameter	Symbol	Conditions	Min	Typ	Max	Unit
Forward voltage	V _F	I _F = 20 mA		1.4	1.7	V
Forward voltage*	V _F	I _F = 100 mA		1.6		V
Reverse voltage	V _R	I _R = 10 μA	5			V
Radiant power	Φ _e	I _F = 20 mA	6	9		mW
Radiant power*	Φ _e	I _F = 100 mA	30	45		mW
Radiant intensity	I _e	I _F = 20 mA	25	35		mW/sr
Radiant intensity*	I _e	I _F = 100 mA		170		mW/sr
Peak wavelength	λ _p	I _F = 20 mA	800	810	820	nm
FWHM	Δλ _{0,5}	I _F = 20 mA		30		nm
Viewing angle	φ	I _F = 20 mA		20		deg.
Switching time	t _r , t _f	I _F = 20 mA		40		ns

*measured after 30 s current flow



Data sheet

Infrared LED

EOLD-810-525

Radiant power vs. forward current (typical)
normalized to Φ_e @ $I_F = 20$ mA

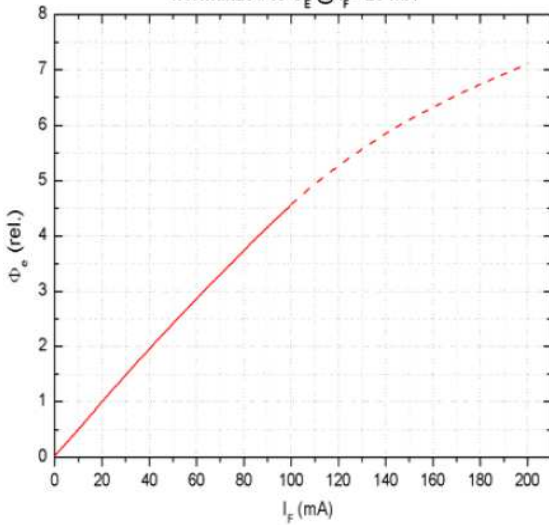

Forward current vs. forward voltage (typical)

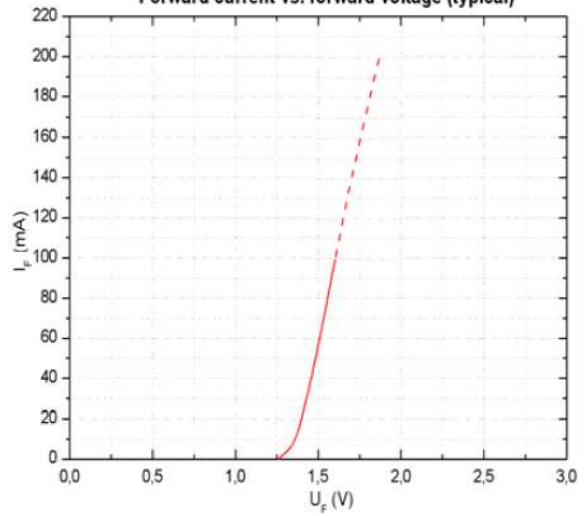

Spectral power distribution (typical)
at $I_F = 20$ mA

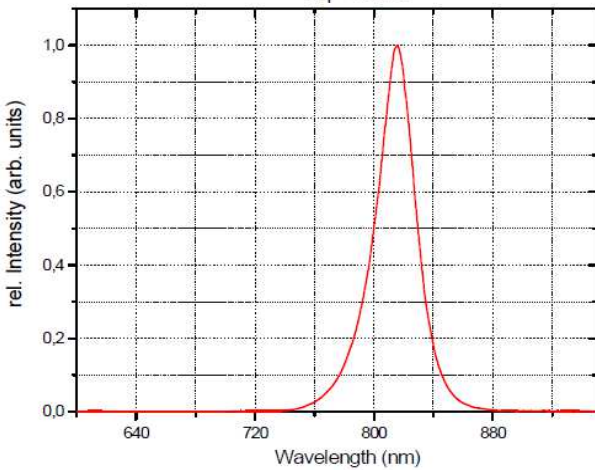

Typical wavelength shift vs. forward current
(rel. to λ_p @ $I_F = 20$ mA)

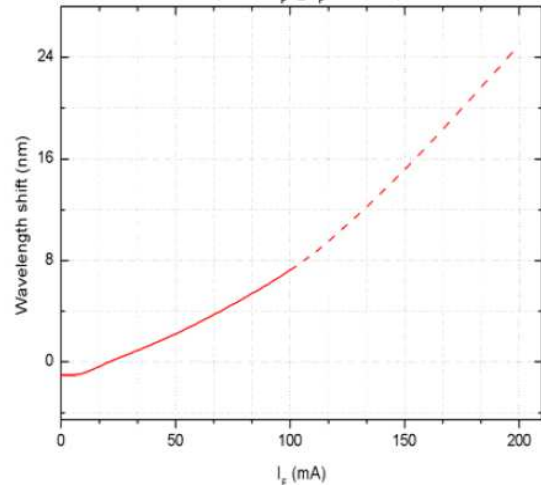

Data sheet

Infrared LED

EOLD-810-525

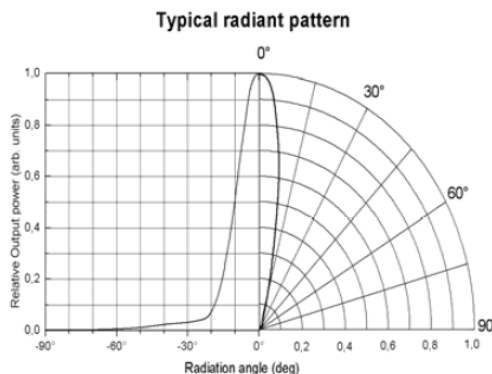
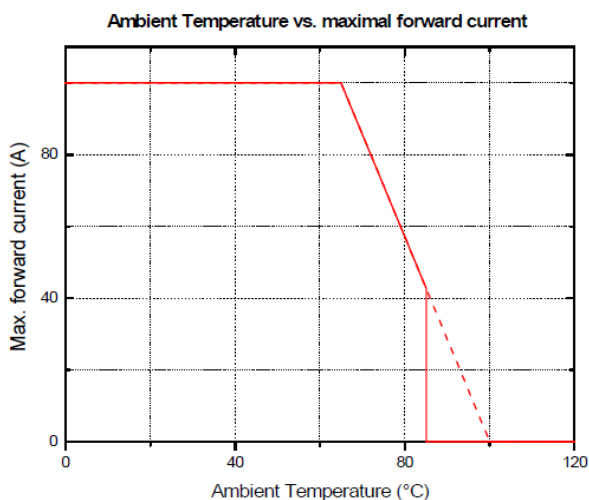

Remarks concerning optical radiation safety*

At low Forward current (<50 mA), and continuous operation, this LED may be classified as LED product Class 1 , according to standard IEC 60825-1:A2. Class 1 products are safe to eyes and skin under reasonably predictable conditions. This implicates a direct observation of the light beam by means of optical instruments.

When driven with higher continuous Forward current, (up to 100 mA), this product should be classified as LED product Class 1M, according to standard IEC 60825-1:A2. Class 1M products are safe to eyes and skin under normal conditions, including when users view the light beam directly. Class 1M products produce either a highly divergent beam or a large diameter beam, so only a small part of the whole light beam can enter the eye. However, such optical products can be harmful to the retina if the beam is viewed using magnifying optical instruments. Therefore, users should not incorporate optics that could concentrate the output into the eyes.

*Note: Safety classification of an optical component mainly depends on the intended application and the way the component is being used. Furthermore, all statements made to classification are based on calculations and are only valid for this LED "as it is", and at continuous operation. Using pulsed current or altering the light beam with additional optics may lead to different safety classifications. Therefore these remarks should be taken as recommendation and guideline only.

Art. No. 430 015



We reserve the right to make changes to improve technical design and may do so without further notice. Parameters can vary in different applications. All operating parameters must be validated for each customer application by the customer.